

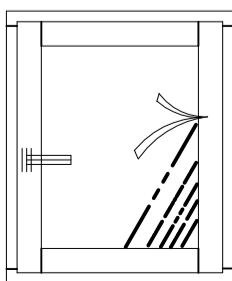

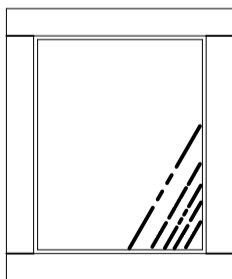

Machinery - Macchina Weight-Peso Kg	Client reference- Rif.Cliente		Part- Parte
	Description Descrizione		
 HIGH TECH TOOLS Via dell'Artigiano 57 (ZU) - 39048 Rovereto (TN) Italy Tel. 0039 0464 43383 / Fax 436316 / E-Mail: info@twtools www.twt.tools	ESPERIA LIFE 80		00D_1V_01
	Signature Firma	Scale Scala	Date Data 24/01/17
Revision Rev.	Date Data	Signature Firma	04004 SERIE_TF 0030608

REPLICATION ENDOUR TRANSMISSION TO OTHERS IS FORBIDDEN
 APPROVAZIONE E TRASMISSIONE A TERZI VIETATA

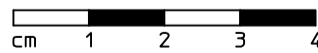
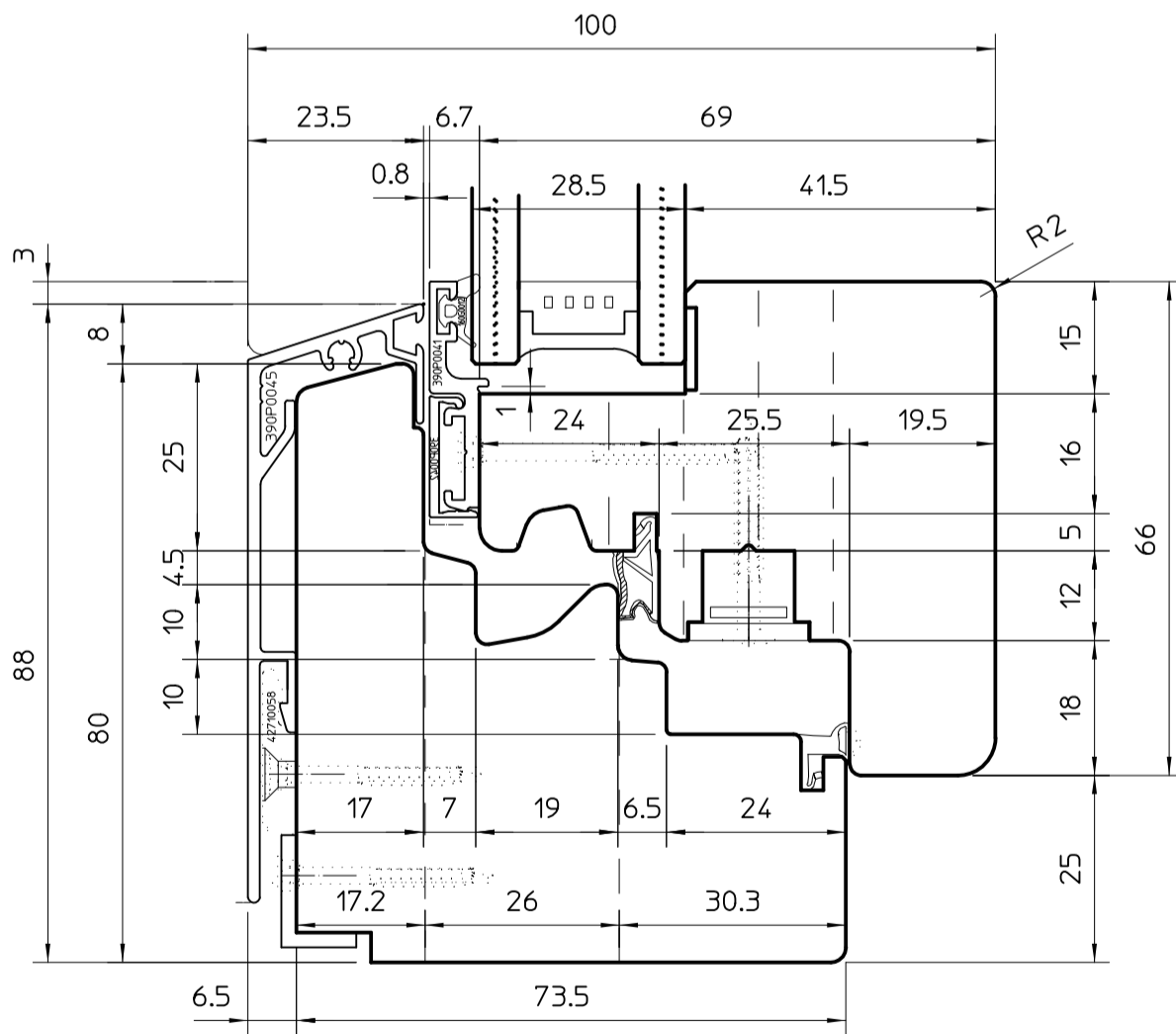
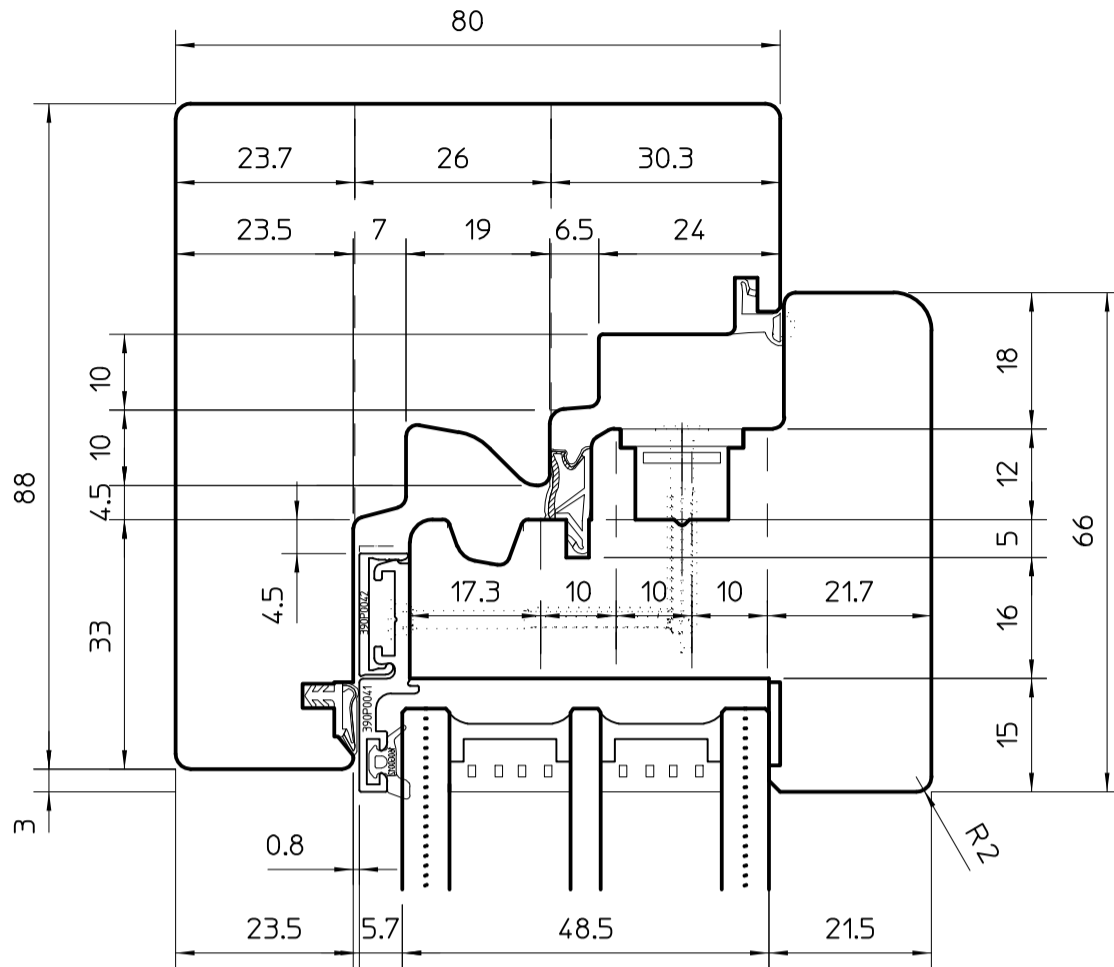



REPLICATION ENDOUR TRANSMISSION TO OTHERS IS FORBIDDEN RIPRODUZIONE E TRASMISSIONE A TERZI VIETATA	Machinery - Macchina	Weight-Peso	Client reference- Rif.Cliente	  Part- Parte	
		Kg			
	 TWT HIGH TECH TOOLS		Description	Drawing n°- Disegno n. 00D_1V_02	
	Via dell'Artigiano 57 (Z.U.) - 39048 Rovereto (TN) Italy Tel. 0039 0464 433883 / Fax 436316 / E-Mail: info@twt.tools www.twt.tools		Signature Firma	Scale Scala	Date Data
		Revision Rev.	Date Data	Signature Firma	
			24/01/17	Code n°- Codice n. 04004 SERIE_TF 0030608	

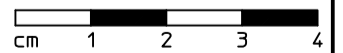
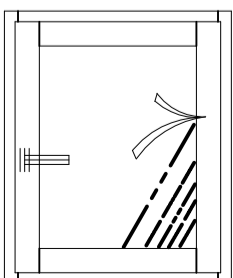
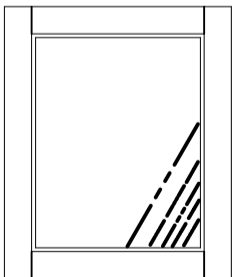
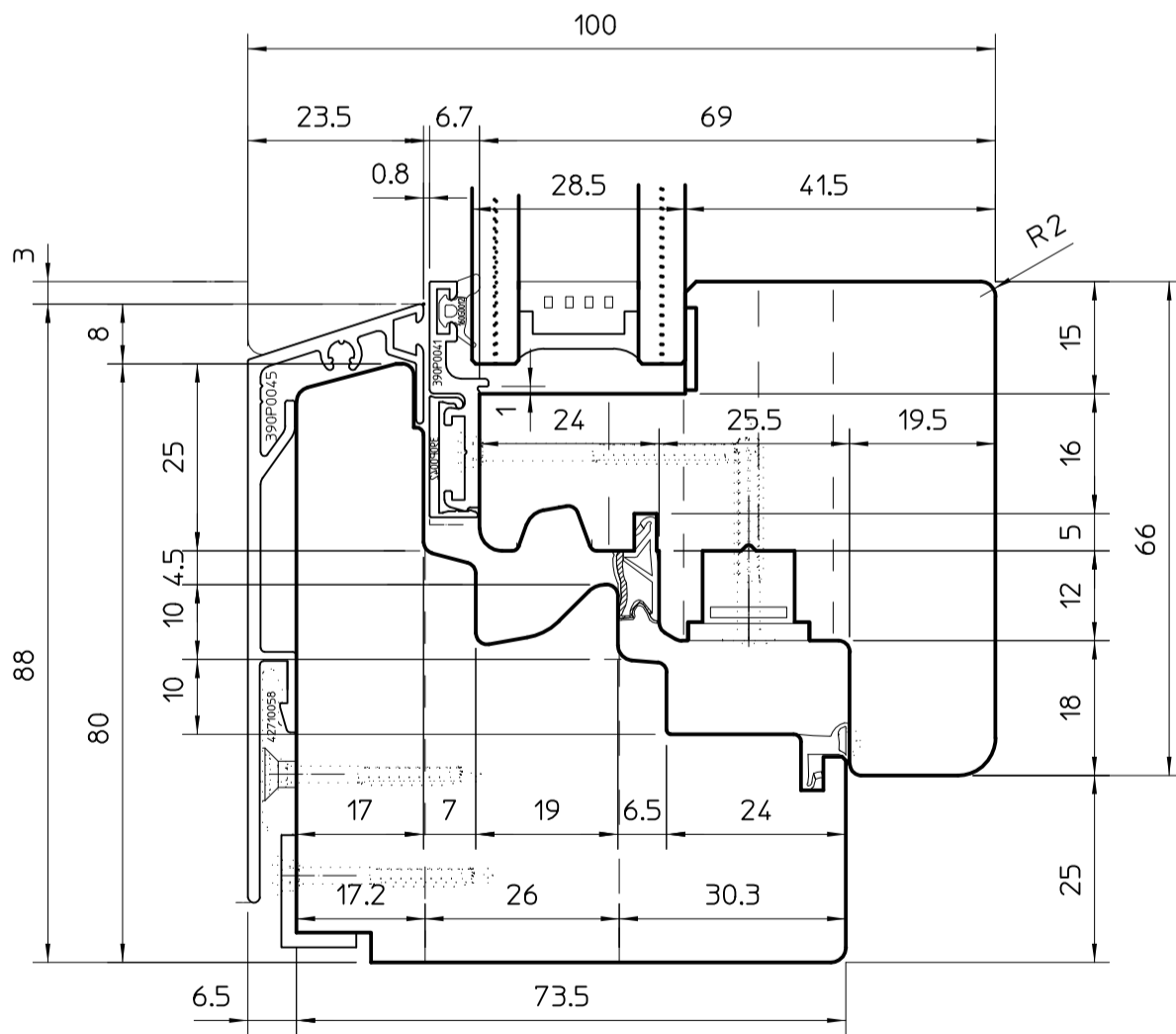
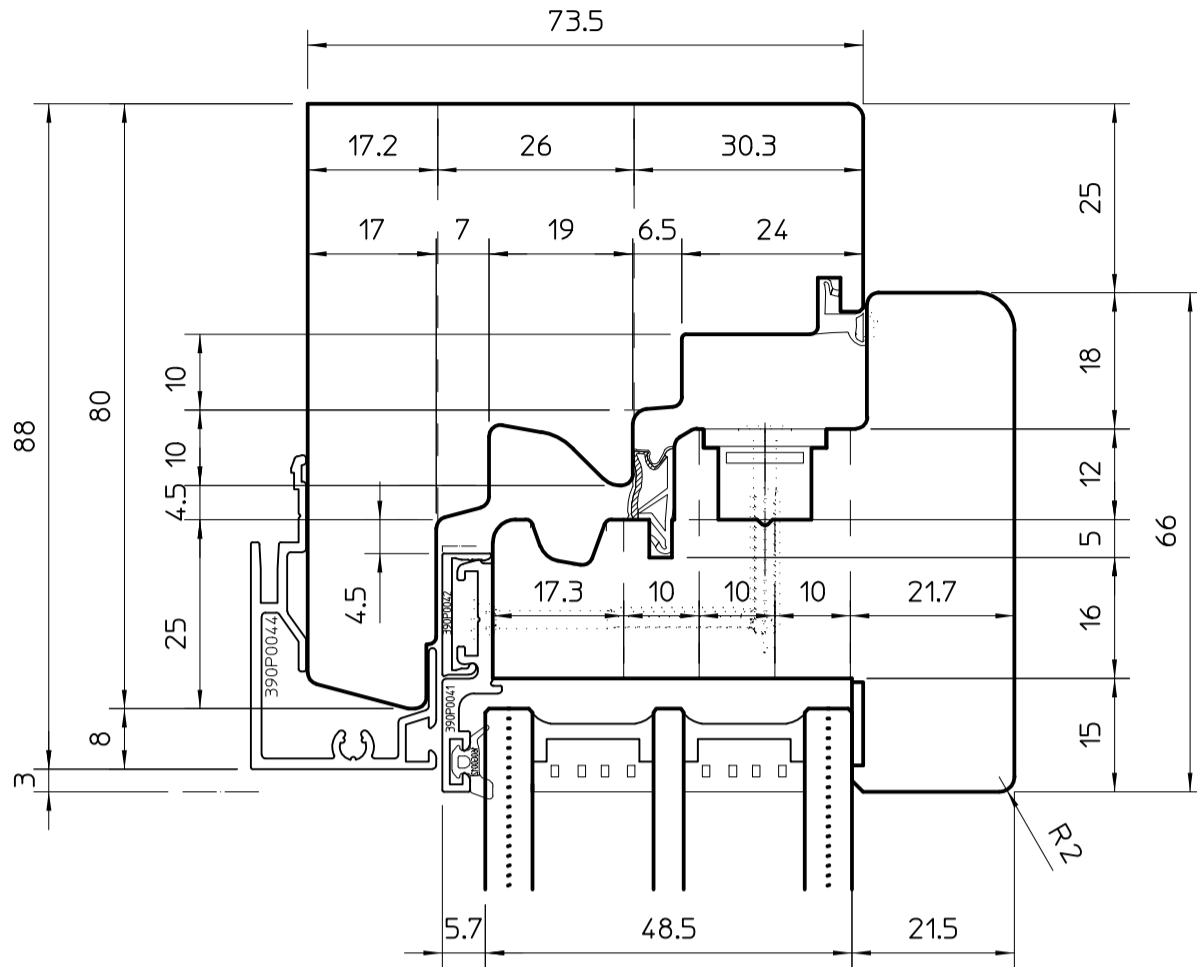
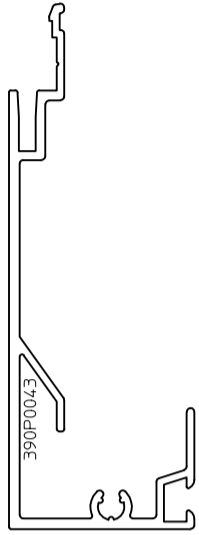

REKORD HIGH TECH TOOLS Via dell'Artigiano 57 (ZU) - 38068 Rovereto (TN) Italy Tel. 0039 0464 43383 / Fax 436316 / E-Mail: info@ht.tools www.ht.tools	Machinery - Macchina	Weight-Peso Kg	Client reference- Rif.Cliente	Part- Parte
	Description Descrizione ESPERIA LIFE 80			Drawing n°- Disegno n. 00D_1V_03
	Signature Firma	Scale Scala	Date Data 24/01/17	Code n°- Codice n. 04004 SERIE_TF 0030608
	Revision Rev.	Date Data	Signature Firma	

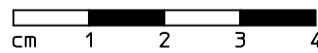
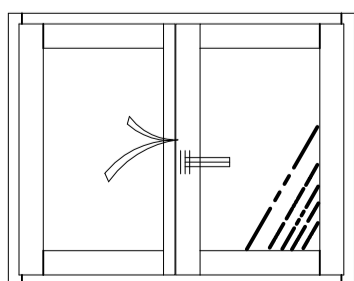
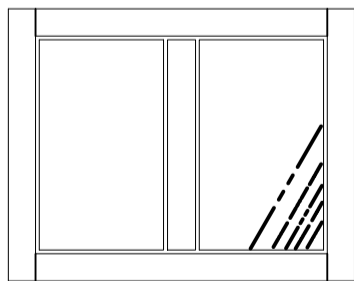
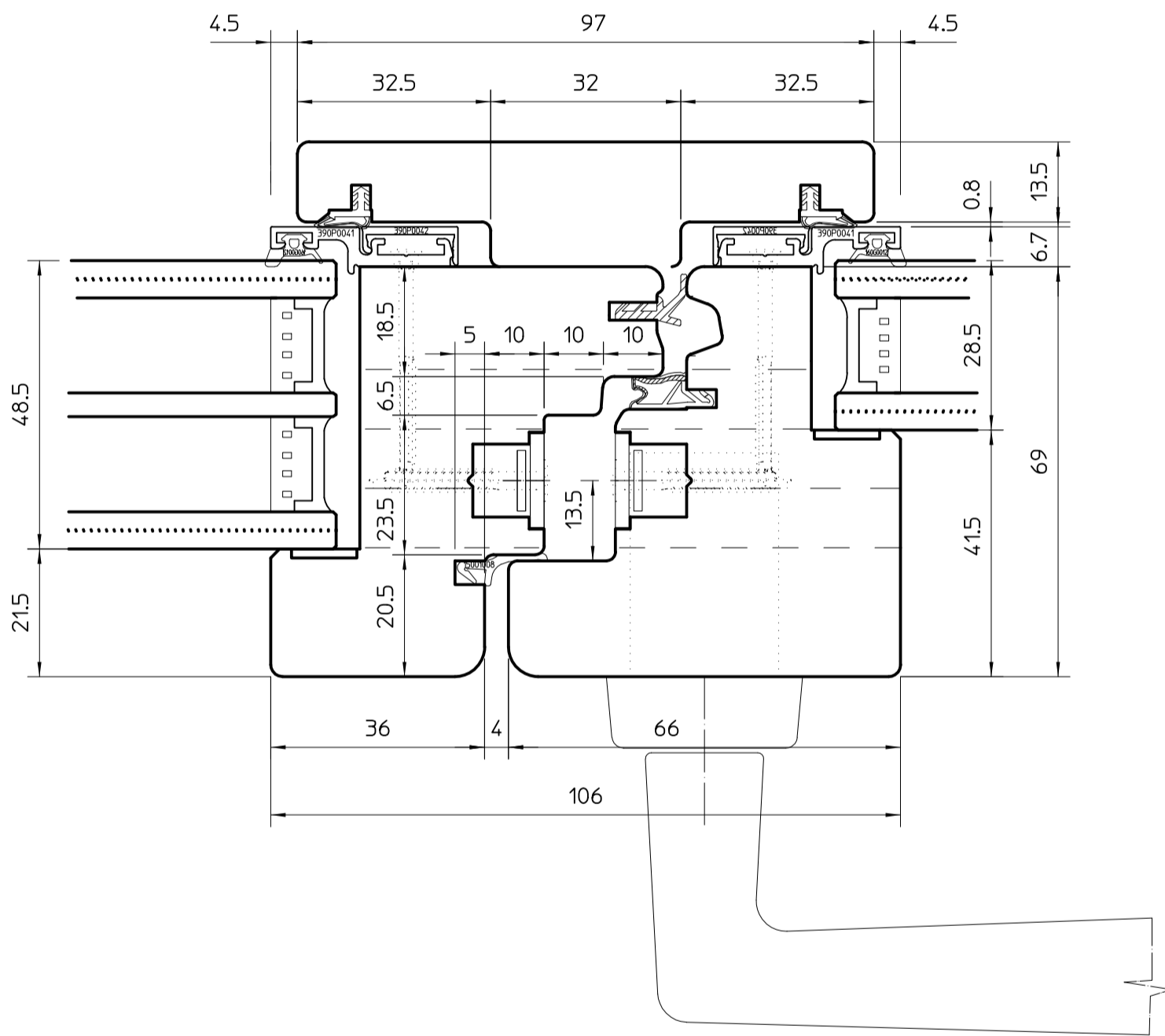

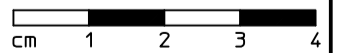
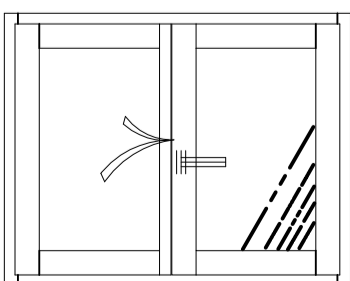
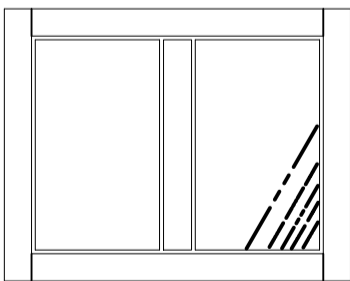
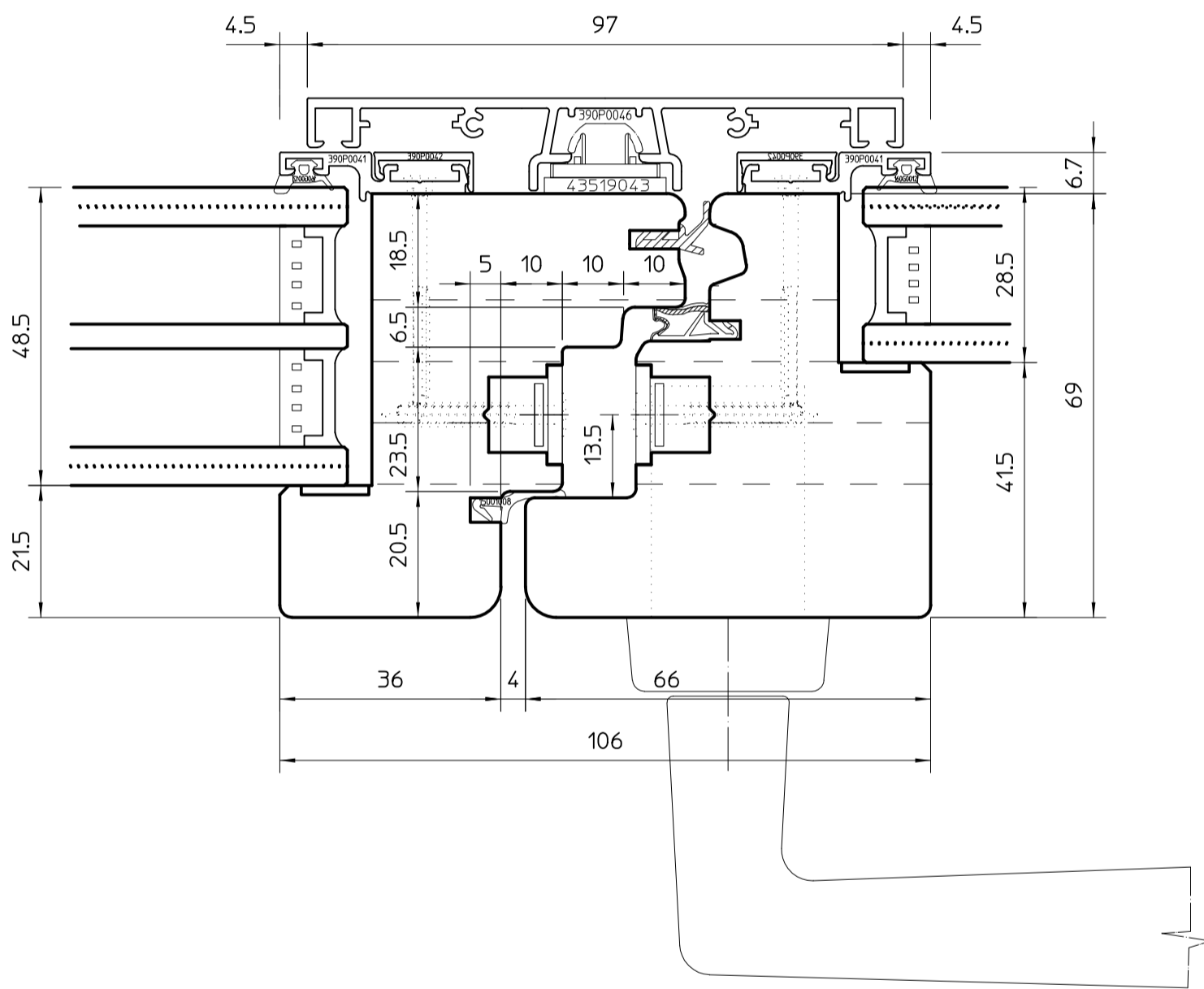

REPLICATION ENDOUR, TRANSMISSION TO OTHERS IS FORBIDDEN. RIPRODUZIONE E TRASMISSIONE A TERZI VIETATA.	Machinery - Macchina	Weight-Peso	Client reference- Rif.Cliente	Part- Parte
		Kg		
 Via dell'Artigiano 57 (Z.U.) - 39068 Rovereto (TN) Italy Tel. 0039 0464 433883 / Fax 436316 / E-Mail: info@twtools www.twtools	Description Descrizione		Drawing n°- Disegno n.	
	ESPERIA LIFE 80		00D_2C_01	
Signature Firma	Scale Scala	Date Data	Code n°- Codice n.	
Revision Rev.	Date Data	Signature Firma	04004 SERIE_TF 0030608	

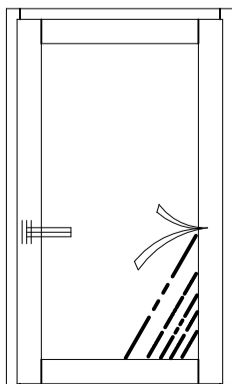
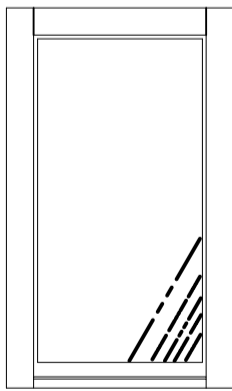
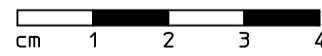
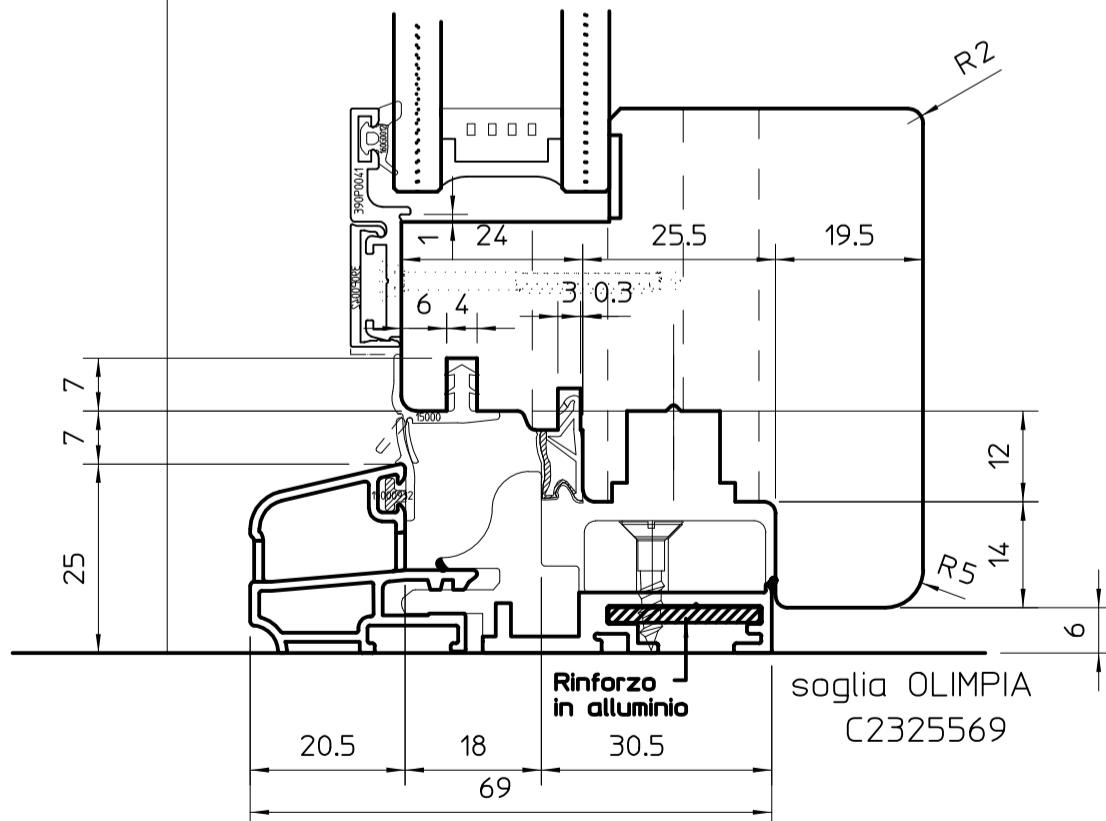
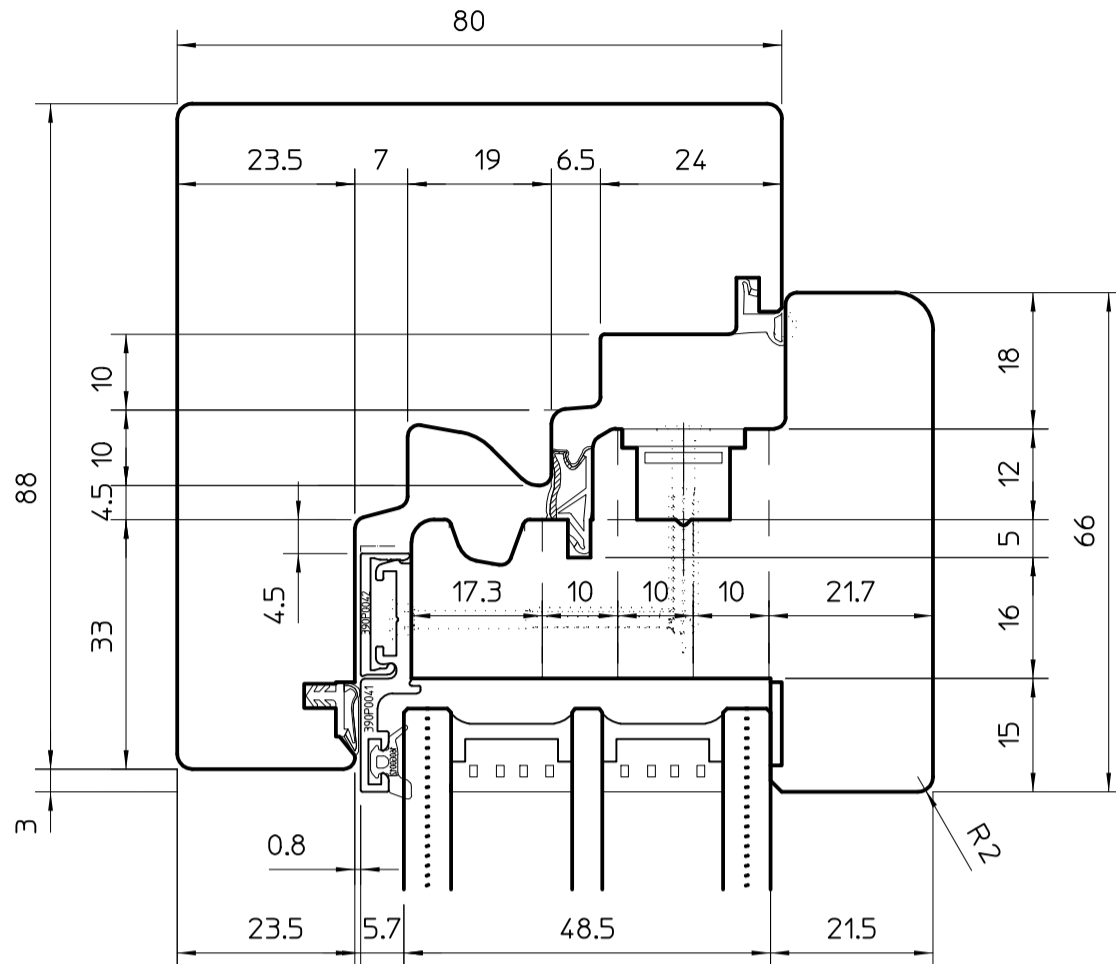

REPLICAZIONE ENDOUR. TRASMISSIONE TO OTHERS IS FORBIDDEN. APPROVAZIONE E TRASMISSIONE A TERZI VIETATA.	Machinery - Macchina	Weight-Peso	Client reference- Rif.Cliente	Part- Parte
		Kg		
 Via dell'Artigiano 57 (ZL) - 39048 Rovereto (TN) Italy Tel. 0039 0464 433883 / Fax 436316 / E-Mail: info@twtools www.twtools	Description Descrizione		Drawing n°- Disegno n.	
	ESPERIA LIFE 80		00D_2C_02	
Signature Firma	Scale Scala	Date Data	Code n°- Codice n.	
Revision Rev.	Date Data	Signature Firma	04004 SERIE_TF 0030608	





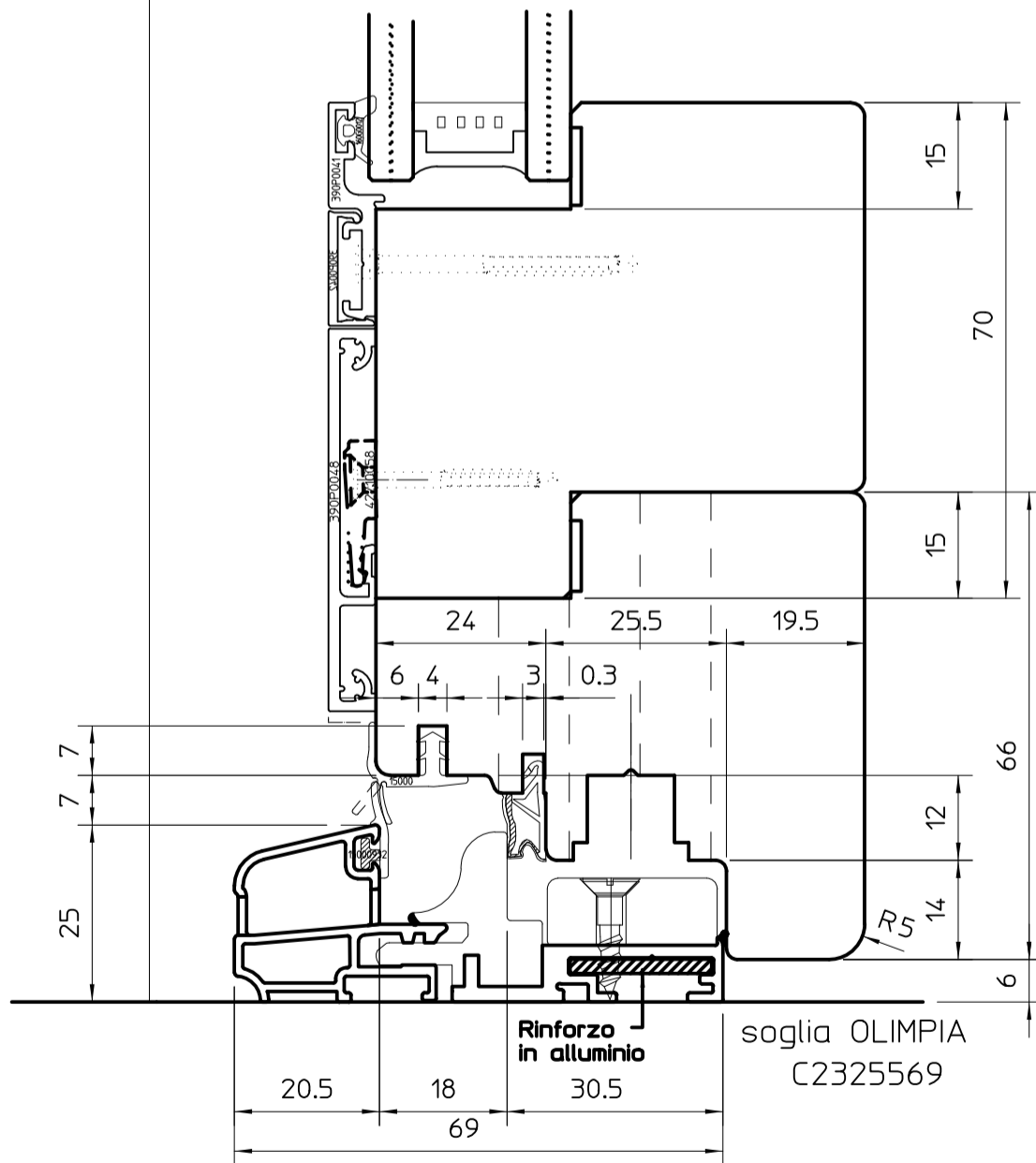
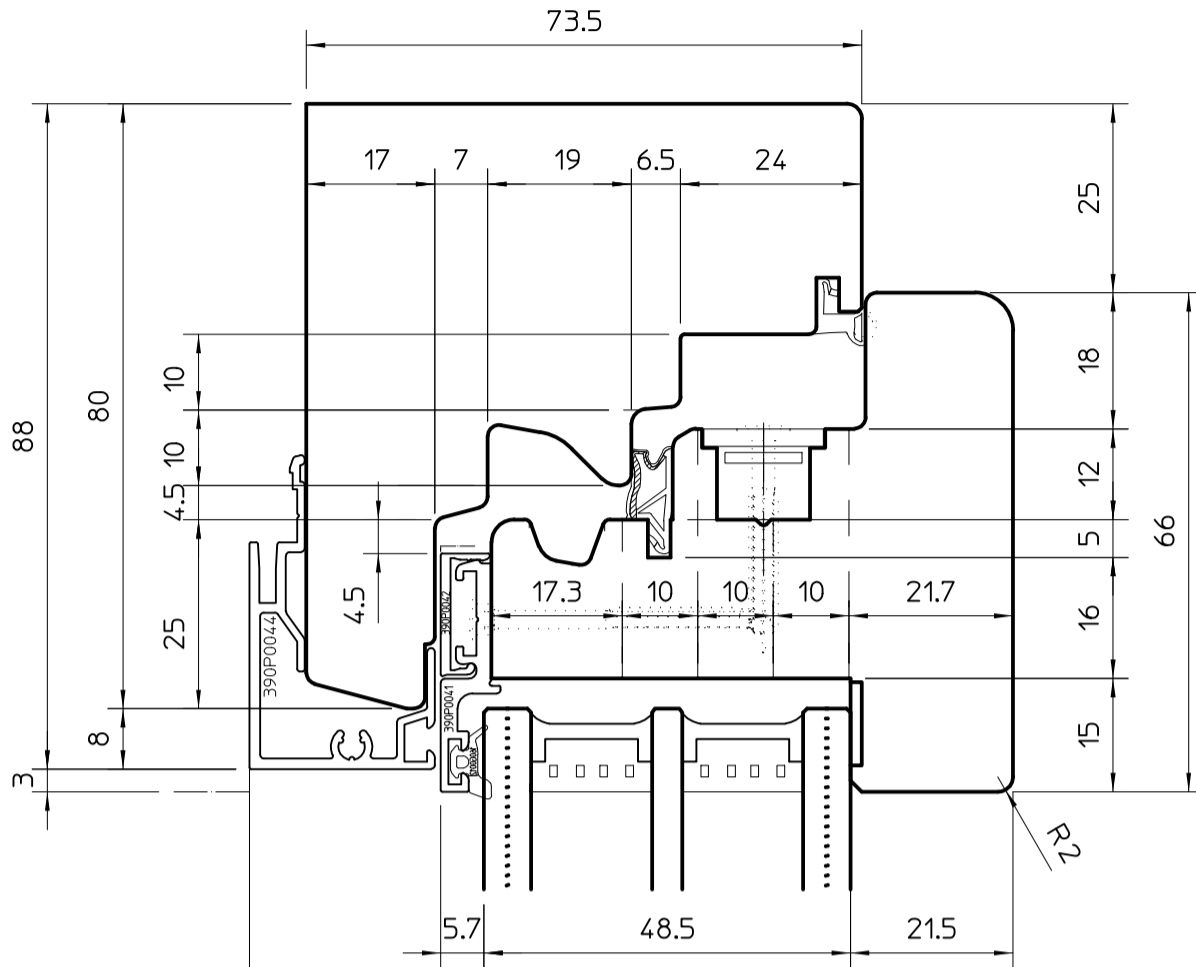

Machinery - Macchina Weight-Peso Kg	Client reference- Rif.Cliente		Part- Parte
	Description Descrizione		
 HIGH TECH TOOLS Via dell'Artigiano 57 (ZU) - 39068 Rovereto (TN) Italy Tel. 0039 0464 433883 / Fax 436316 / E-Mail: info@twtools www.twt.tools	ESPERIA LIFE 80		Drawing n°- Disegno n. 00D_3P_01
	Signature Firma Revision Rev.	Scale Scala Date Data	Date Data Signature Firma
			

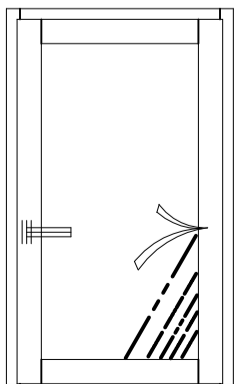
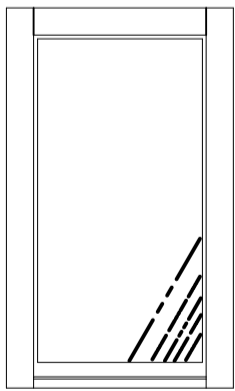
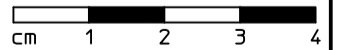

Rinforzo
in alluminio

soglia OLIMPIA
C2325569



Machinery - Macchina Weight-Peso Kg  TWT HIGH TECH TOOLS Via dell'Artigiano 57 (ZU) - 39068 Rovereto (TN) Italy Tel. 0039 0464 433883 / Fax 436316 / E-Mail: info@twtools www.twtools	Client reference- Rif.Cliente	  Part- Parte	
	Description Descrizione	Drawing n°- Disegno n.	
Signature Firma	Scale Scala	Date Data 24/01/17	00D_3P_02
Revision Rev.	Date Data	Signature Firma	Code n°- Codice n.
			04004 SERIE_TF 0030608

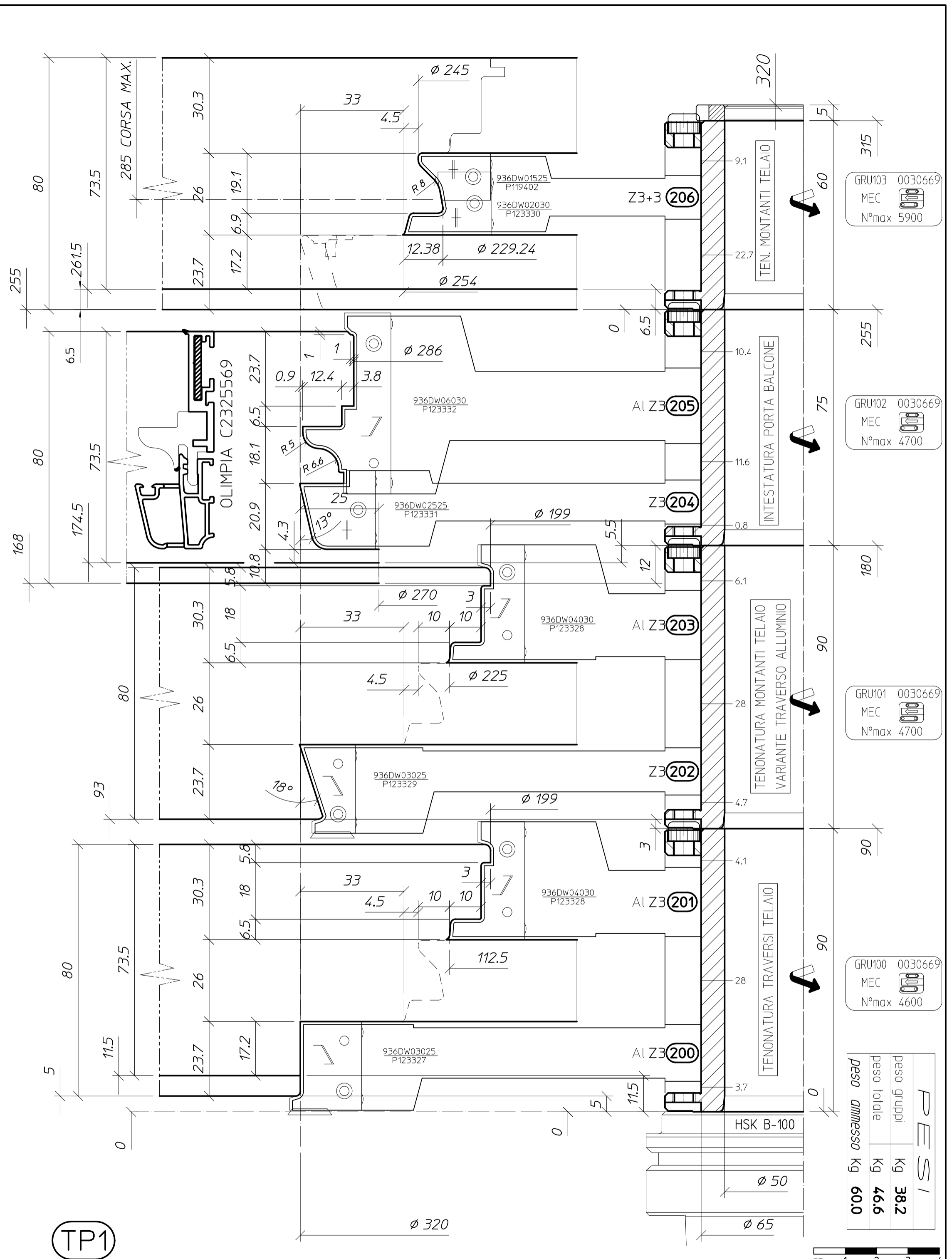

TP1

EQUILIBRATURA GENERALE G2.5
 Corsa vert. totale = 285+5mm
 base partenza = 5mm
 corsa utile = 285
 Velocità di rot. fissa : 3200 giri/min.
 ØMAX. 320mm (330 sul tagliante)
 PESO MAX utensili + albero (8.4Kg) = 60 Kg.

Machinery - Macchina	Weight-Peso Kg	Client reference- Rif.Cliente	Part- Parte
		Description SAOMAD : ALBERO A TENONARE	Drawing n°- Disegno n. 001
		Signature Firma D. Agostino	Date Data 24/01/17
		Revision Rev.	Code n°- Codice n. 04004 SERIE_TF 0030669

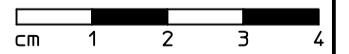

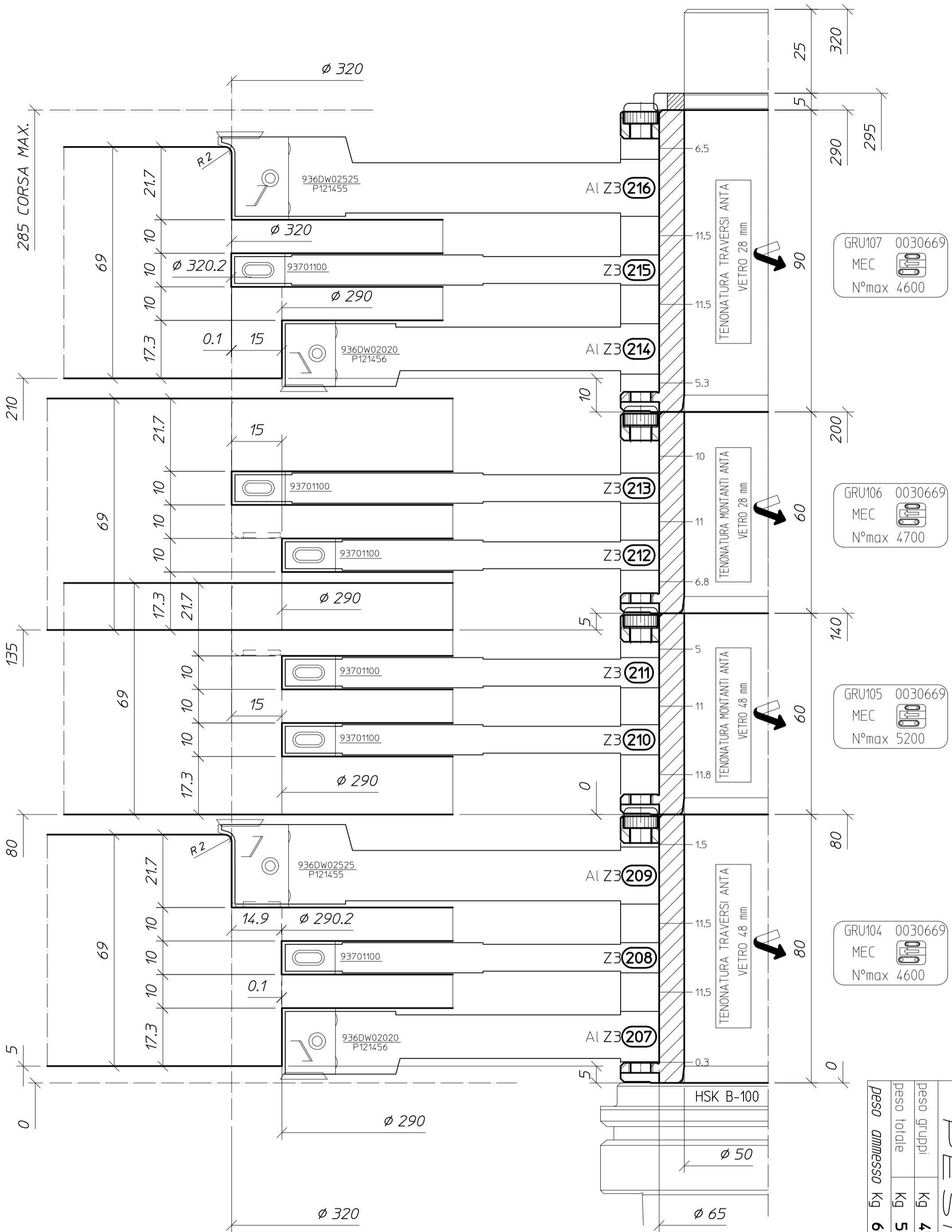

GRU107 0030669
MEC
N°max 4600

GRU106 0030669
MEC
N°max 4700

GRU105 0030669
MEC
N°max 5200

GRU104 0030669
MEC
N°max 4600

P E S I	
peso gruppi	Kg 45.7
peso totale	Kg 54.1
peso ammasso	Kg 60.0

TP1

EQUILBRATURA GENERALE G2.5
 Corsa vert. totale = 285+5mm
 base partenza = 5mm
 corsa utile = 285
 Velocità di rot. fissa : 3200 giri/min.
 ØMAX. 320mm (330 sul tagliente)
 PESO MAX utensili + albero (8.4Kg) = 60 Kg.

Machinery - Macchina	Weight-Peso Kg	Client reference- Rif.Cliente	Part- Parte
 <small>Via dell'Artigiano 57 (ZL) - 38068 Rovereto (TN) Italy Tel. 0039 0464 439183 / Fax 436316 / E-Mail: info@twt.tools</small>		Description SAOMAD : ALBERO A TENONARE	Drawing n°- Disegno n. 002
		Signature Firma <i>D. Agostino</i>	Date Data 24/01/17
Revision Rev.		Date Data	Signature Firma
		Code n°- Codice n. 04004 SERIE_TF 0030669	

285 CORSA MAX.

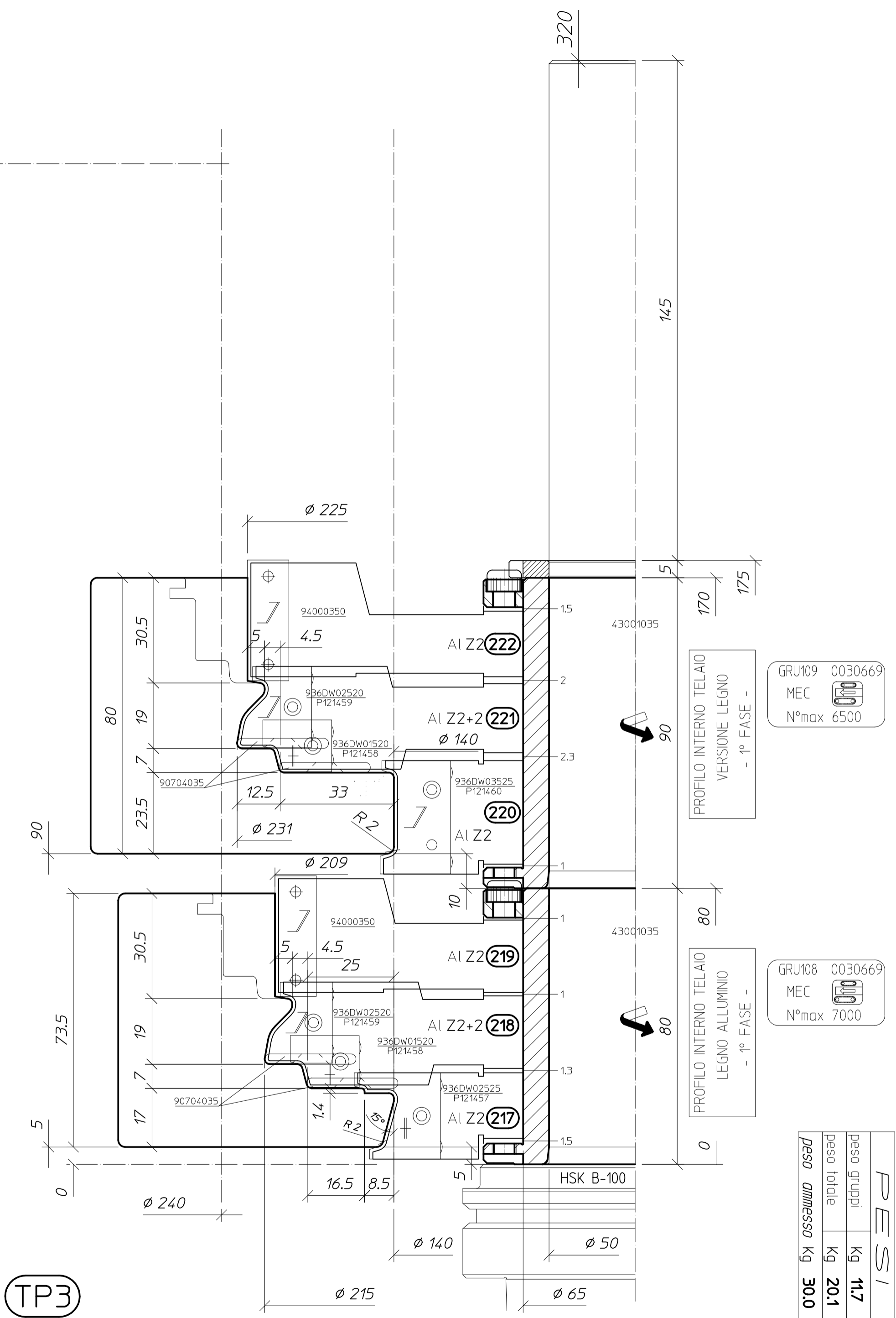

TP3

GRU109 0030669
MEC
N°max 6500

GRU108 0030669
MEC
N°max 7000

P E S S I	
peso gruppi	Kg 11.7
peso totale	Kg 20.1
peso ammesso	Kg 30.0

EQUILIBRATURA GENERALE G2.5
 Corsa vert. totale = 285+5mm
 base partenza = 5mm
 corsa utile = 285
 Velocità di rot. fissa : 6000 giri/min.
 ØMAX. 240mm (sul tagliente)
 PESO MAX utensili + albero (8.4Kg) = 30 Kg.

Machinery - Macchina	Weight-Peso Kg	Client reference- Rif.Cliente	Part- Parte
 Via dell'Artigianato 57 (ZL) - 38068 Rovereto (TN) Italy Tel. 0039 0464 439183 / Fax 436316 / E-Mail: info@twt.tools WWW.twt.tools		Description SAOMAD : 1° ALBERO A PROFILARE	Drawing n°- Disegno n. 003
Signature Firma D. Agostino	Scale Scala	Date Data 24/01/17	Code n°- Codice n. 04004 SERIE_TF 0030669
Revision Rev.	Date Data	Signature Firma	

285 CORSA MAX.

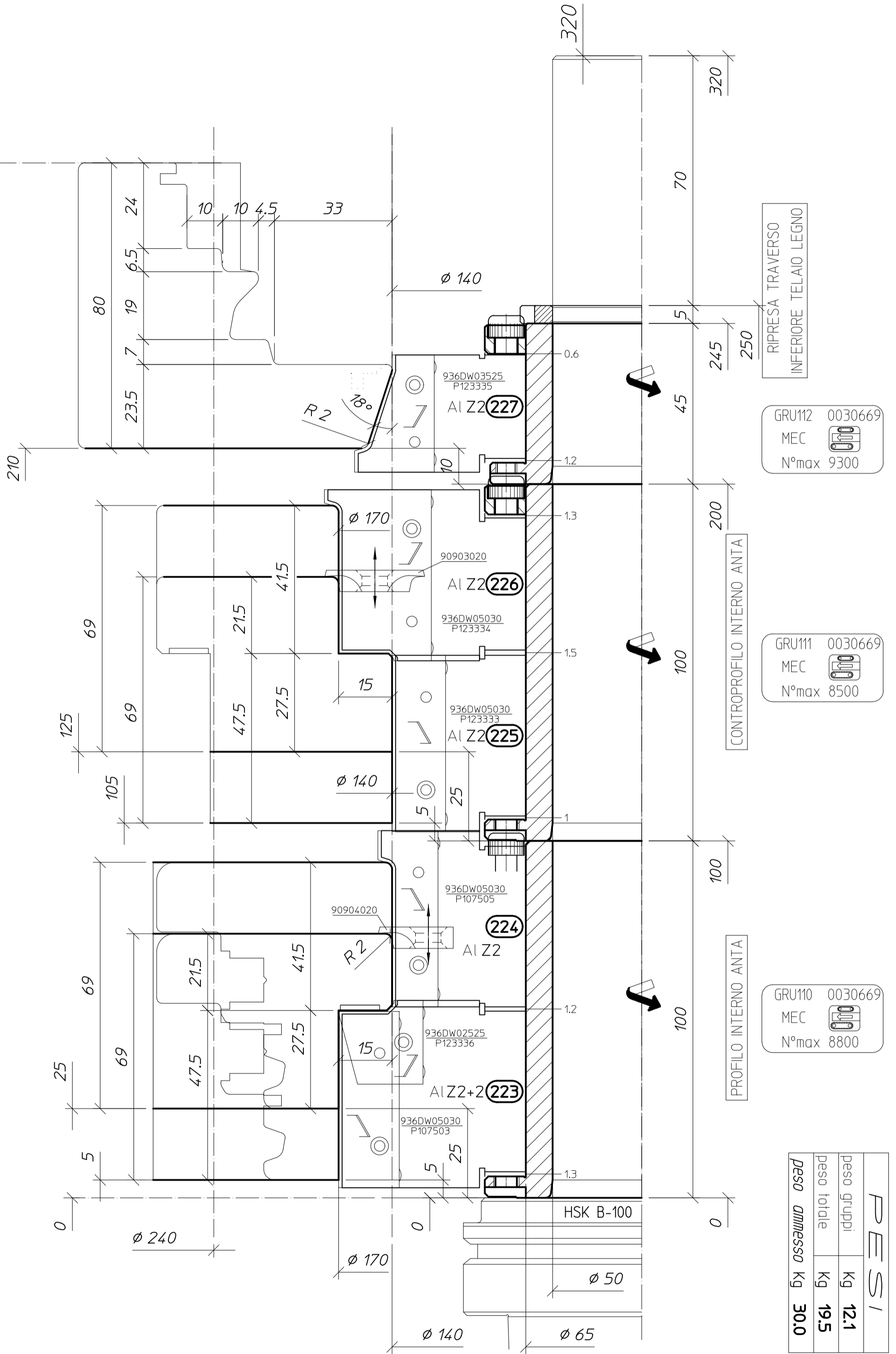

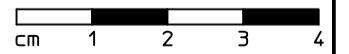

TP4

EQUILIBRATURA GENERALE G2.5
 Corsa vert. totale = 285+5mm
 base partenza = 5mm
 corsa utile = 285
 Velocità di rot. fissa : 6000 giri/min.
 ØMAX. 240mm (sul tagliente)
 PESO MAX utensili + albero (8,4Kg) = 30 Kg.

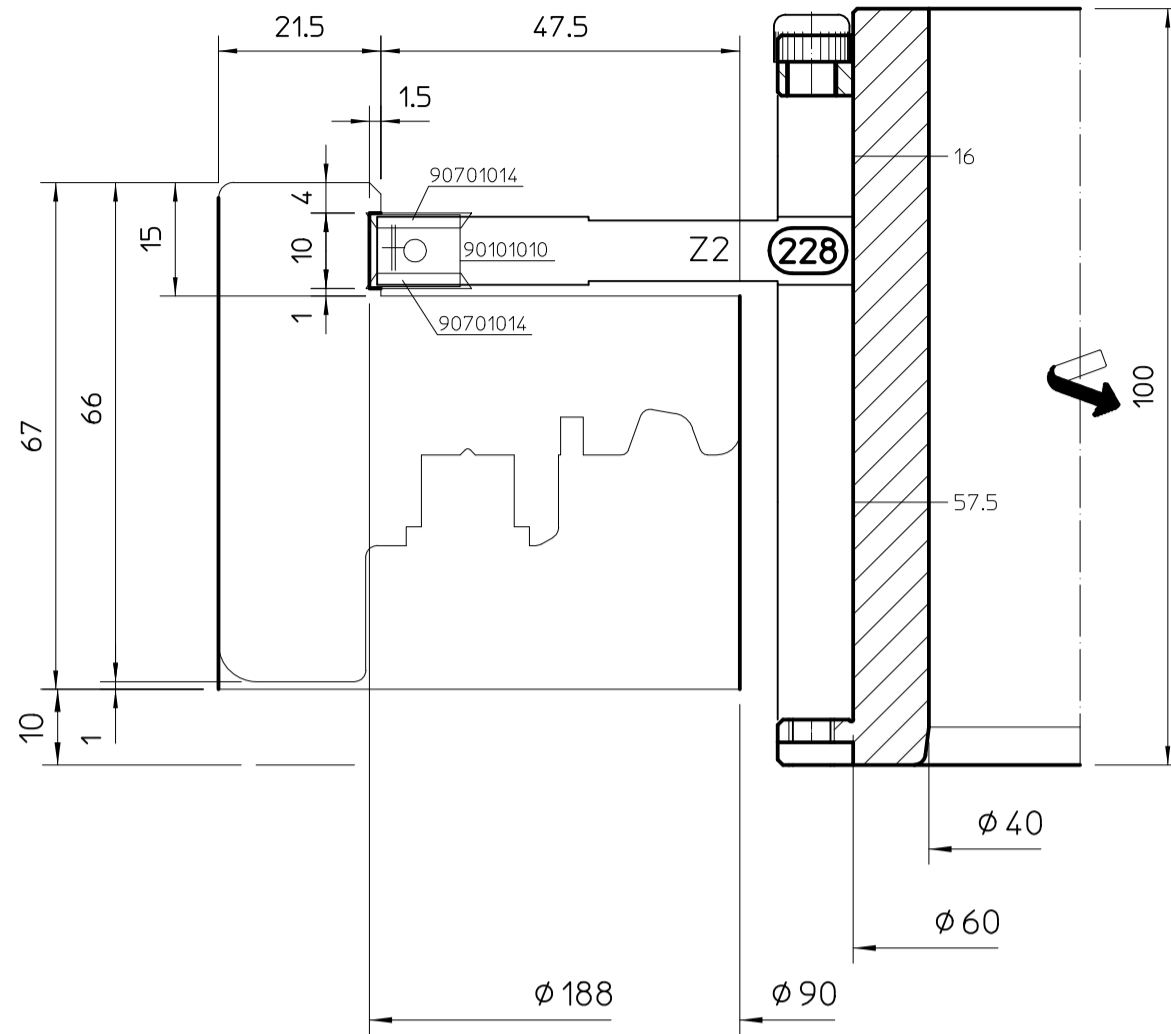

Machinery - Macchina Weight-Peso Kg	Client reference- Rif.Cliente		Part- Parte Drawing n°- Disegno n. 004
	Description Descrizione SAOMAD : 2° ALBERO A PROFILARE		
 Via dell'Artigiano 57 (ZL) - 38068 Rovereto (TN) Italy Tel. 0039 0464 439183 / Fax 436316 / E-Mail: info@twttools.com WWW.TWT.TOOLS	Signature Firma D'Agostino	Scale Scala Date Data	Date Data 24/01/17
	Revision Rev.	Date Data	Signature Firma



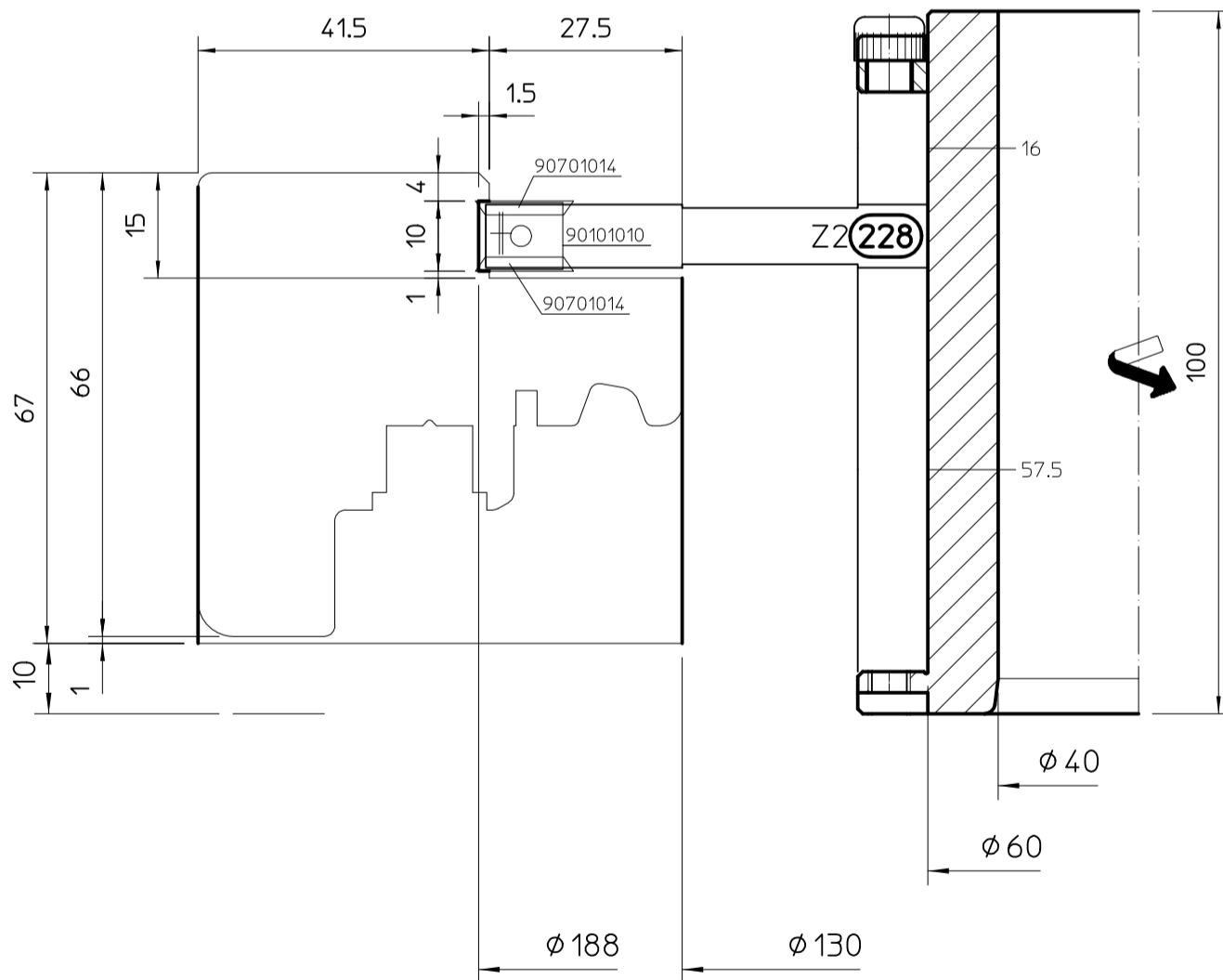

GRU113 0030669
 MAN 
 N°min 4000
 N°max 8000



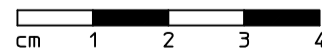

GRU113 0030669
 MAN 
 N°min 4000
 N°max 8000



<small>REPLAZIONE ENDOUR, TRASMISSIONI, OTHERS, S. FROBBERI APPROVAZIONE E TRASMISSIONE A TERZI VEIATA</small>	Machinery - Macchina TOUPIE	Weight-Peso Kg	Client reference- Rif.Cliente		Part- Parte
	 <small>Via dell'Artigiano 57 (Z2) - 39048 Rovereto (TN) Italy Tel. 0039 0464 43383 / Fax 436316 / E-Mail: info@twtools www.twtools</small>			Description Descrizione SEDE GUARNIZIONE TELAIO	Drawing n°- Disegno n. 005
	Signature Firma <i>Beltrami</i>	Scale Scala	Date Data 24/01/17	Code n°- Codice n. 04004 SERIE_TF 0030669	
	Revision Rev.	Date Data	Signature Firma		

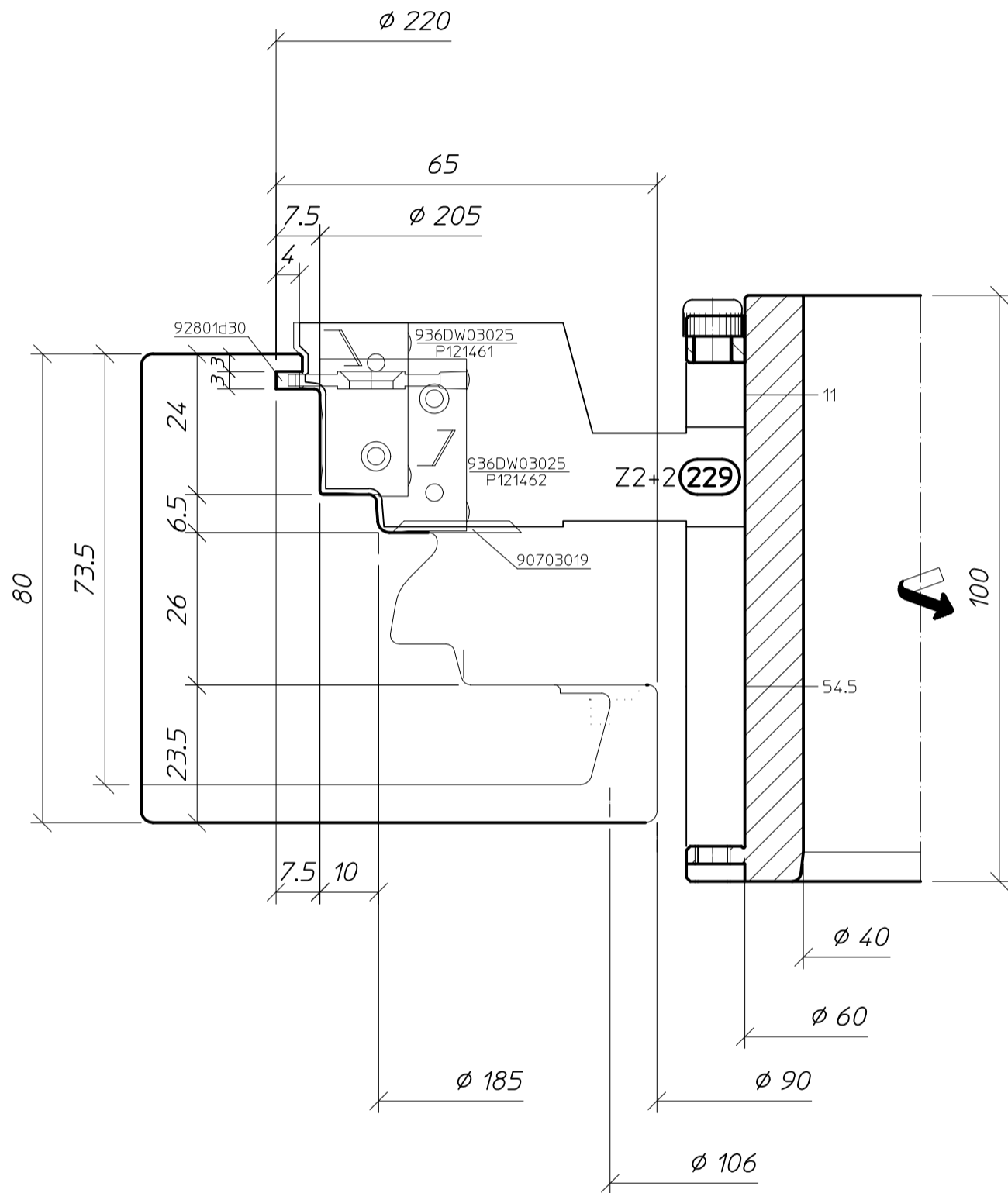

REKORD



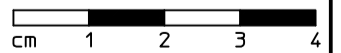

GRU114 0030669
 MAN 
 N°min 3400
 N°max 6900

PROFILO TELAIO LEGNO
 E LEGNO ALLUMINIO
 - 2° FASE -

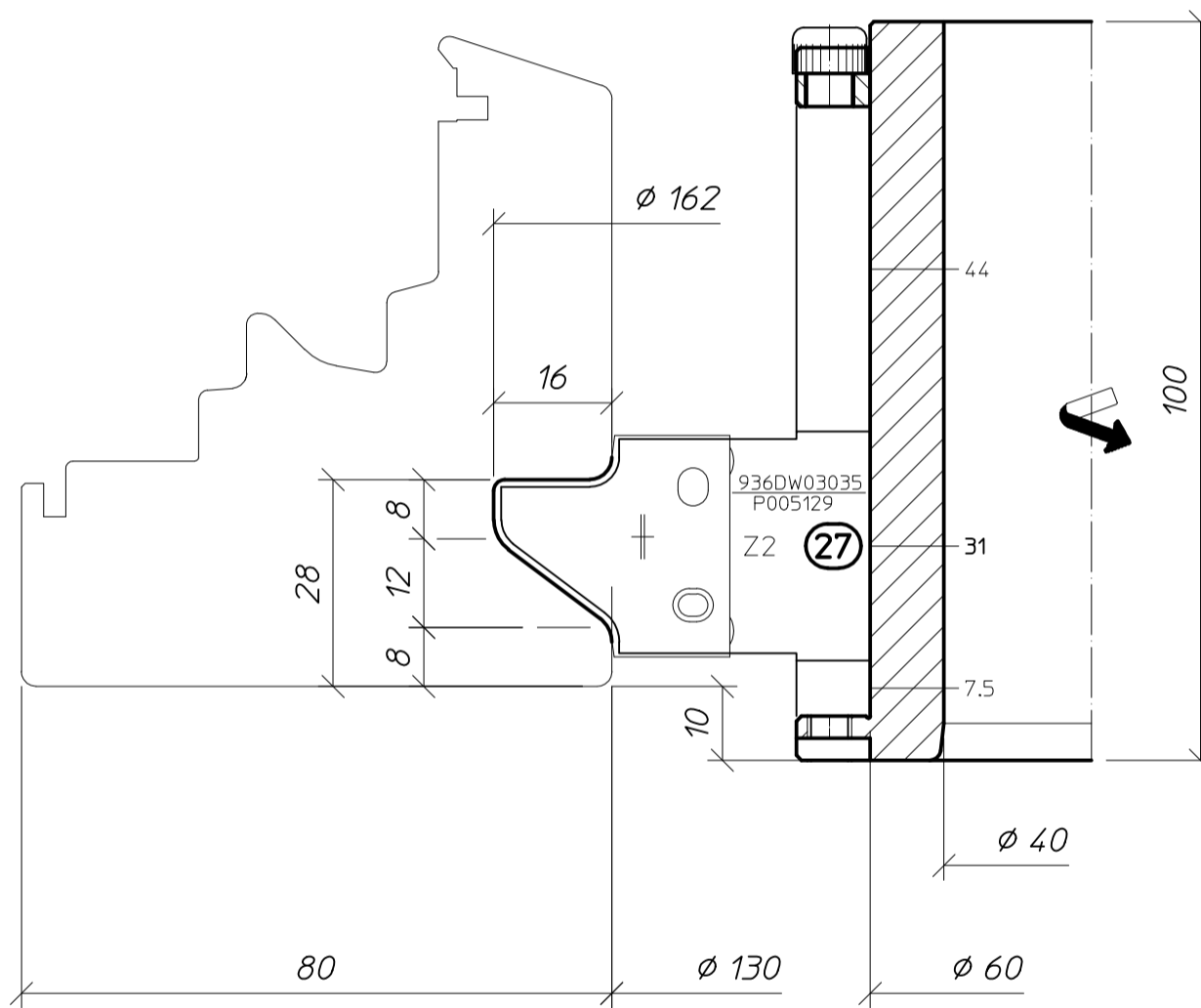

<small>REPLICATION ENDOR. TRANSMISSION TO OTHERS IS FORBIDDEN. APPROVAZIONE E TRASMISSIONE A TERZI VIETATA</small>  <small>Via dell'Artigiano 57 (ZZ) - 39068 Rovereto (TN) Italy Tel. 0039 0464 43383 / Fax 436316 / E-Mail: info@twtools www.twtools</small> 	Machinery - Macchina	Weight-Peso	Client reference- Rif.Cliente		  Part- Parte
	TOUPIE	Kg			
	Description Descrizione RIPRESA BATTUTA TELAIO			Drawing n°- Disegno n. 006	
	Signature Firma  Revision Rev.	Scale Scala Date Data	Date Data 24/01/17 Signature Firma	Code n°- Codice n. 04004 SERIE_TF 0030669	



29000 0005136
 MAN 
 N°min 4000
 N°max 7500

cm 1 2 3 4

<small>REPLICATION ENDOR. TRANSMISSION TO OTHERS IS FORBIDDEN. APPROVAZIONE E TRASMISSIONE A TERZI VIETATA.</small>  TWT <small>HIGH TECH TOOLS</small> <small>Via dell'Artigiano 57 (ZL) - 39068 Rovereto (TN) Italy Tel. 0039 0464 433883 / Fax 436316 / E-Mail: info@twt.tools www.twt.tools</small>	Machinery - Macchina TOUPIE	Weight-Peso Kg	Client reference- Rif.Cliente	 	Part- Parte	
	 TWT <small>HIGH TECH TOOLS</small>			Description Descrizione RIPRESA SCARICO ACQUA	Drawing n°- Disegno n. 007	
	Signature Firma <i>Beltzoni</i>	Scale Scala	Date Data 24/01/17	Code n°- Codice n.	04004 SERIE_TF 0030669	
	Revision Rev.	Date Data	Signature Firma			



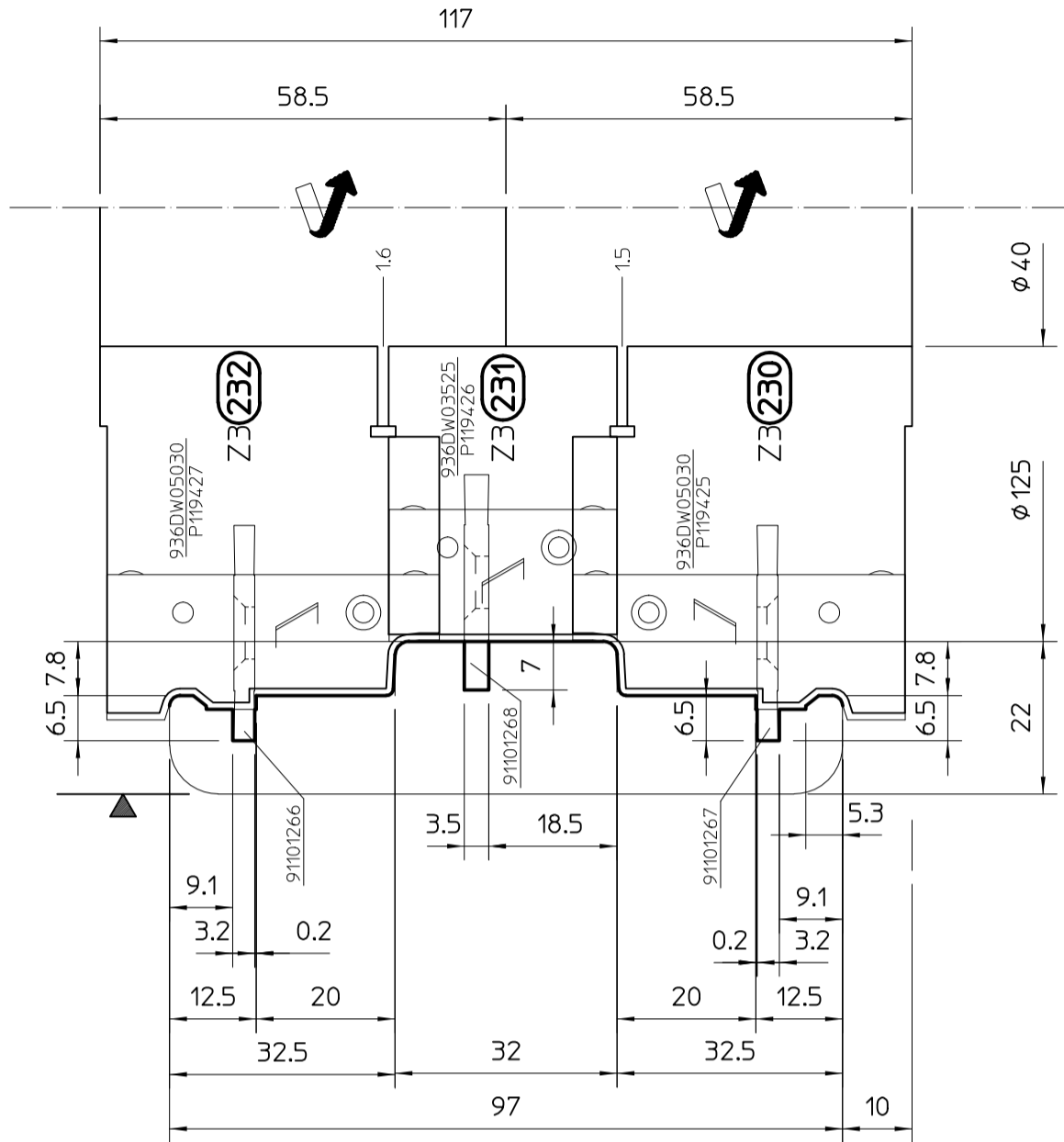

GRU116 0030608
 MEC 
 N°max 9900



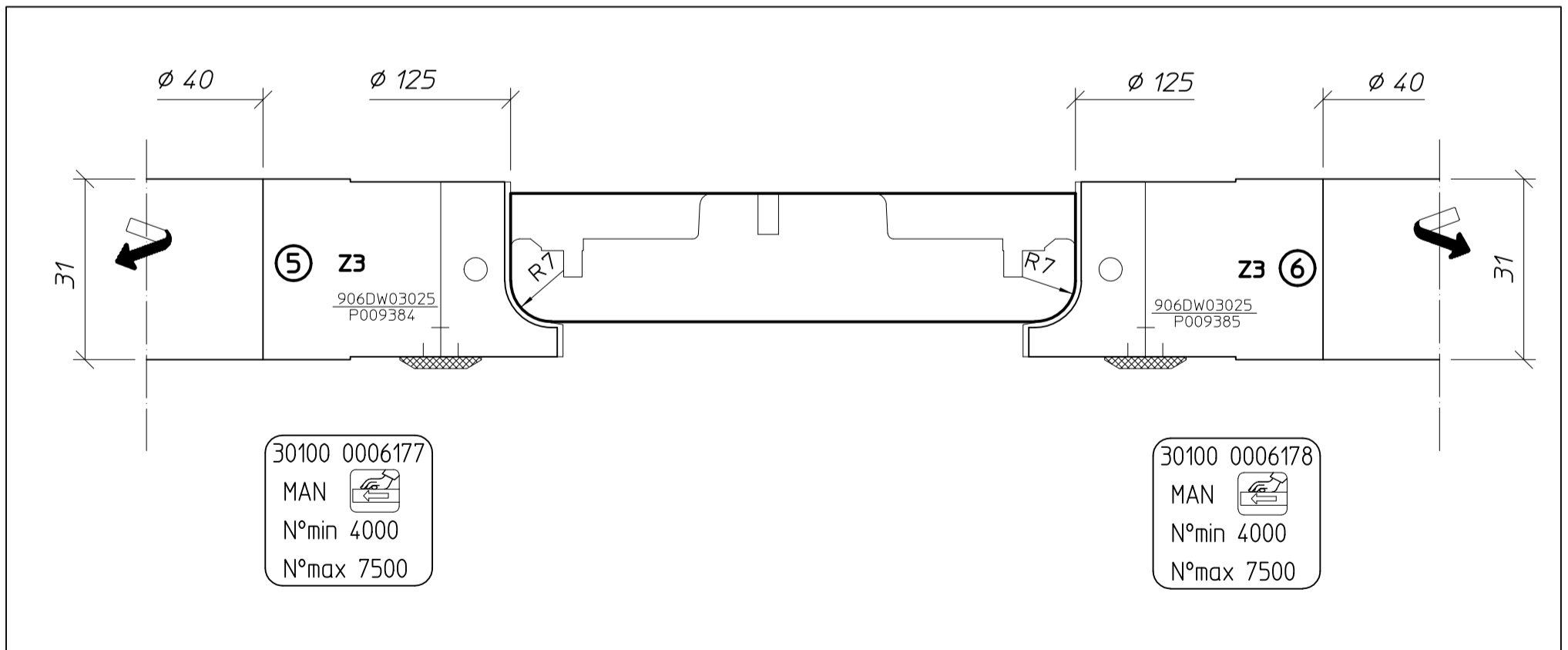

UTENSILI ESISTENTI

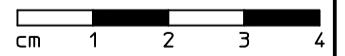

30100 0006177
 MAN 
 N°min 4000
 N°max 7500

30100 0006178
 MAN 
 N°min 4000
 N°max 7500



Machinery - Macchina	Weight-Peso Kg	Client reference- Rif.Cliente		Part- Parte 1/1
 TWT HIGH TECH TOOLS <small>Via dell'Artigiano 57 (ZU) - 39048 Rovereto (TN) Italy Tel. 0039 0464 433883 / Fax 436316 / E-Mail: info@twt.tools www.twt.tools</small>		Description Descrizione	Drawing n°- Disegno n.	
		SCORNICIATRICE - PROFILATURA FASCETTA		008
Signature Firma	Scale Scala	Date Data	Code n°- Codice n.	
Revision Rev.	Date Data	Signature Firma	04004 SERIE_TF 0030608	